

Le pulegge per cinghie trapezoidali presentate dalla SATI nel presente catalogo sono tutte costruite secondo le tabelle ISO 4183 e DIN 2211-3.

V-belt pulleys proposed by SATI in this catalogue are all manufactured according to ISO 4183 and DIN 2211-3 norms.

Die Keilriemenscheiben, die von SATI in diesem Katalog dargestellt sind, sind alle nach ISO 4183 und DIN 2211-3 hergestellt worden.

Les poulies trapézoïdales présentées par la SATI sur ce catalogue sont toutes fabriquées suivant les normes ISO 4183 et DIN 2211-3.

Las poleas para correas trapezoidales presentadas por la SATI en el presente catálogo están todas construidas según las tablas ISO 4183 y DIN 2211-3.

Il materiale impiegato nella costruzione delle medesime è in ghisa EN-GJL-200 UNI EN 1561 e, successivamente alle lavorazioni meccaniche, subiscono un trattamento superficiale di FOSFATAZIONE.

The material used for the construction of these pulleys is cast iron EN-GJL-200 UNI EN 1561 and after the machining all pulleys are being PHOSPHATED.

Das fuer die Produktion verwendete Material ist Grauguss EN-GJL-200 UNI EN 1561 und nach der Bearbeitung werden alle Keilriemenscheiben PHOSPHATIERT.

Le materiel utilisé pour la fabrication des poulies est la fonte EN-GJL-200 UNI EN 1561 et après l'usinage elles sont toutes exposées à un traitement de PHOSPHATATION.

El material empleado en la construcción de las mismas es el hierro fundido EN-GJL-200 UNI EN 1561 y después de las elaboraciones mecánicas están sometidas a un tratamiento superficial de FOSFATACIÓN.

Tutte le pulegge sono equilibrate STATICAMENTE ed idonee ad un funzionamento fino alla velocità periferica di 35 m/s.

All pulleys are STATICALLY balanced and suitable for peripheral speed up to 35 m/s.

Alle Keilriemenscheiben sind STATISCH ausgewuchtet und fuer eine peripherische Betriebsgeschwindigkeit bis 35 m/s.

Toutes les poulies sont équilibrées STATIQUEMENT et propres à tourner à une vitesse périphérique jusqu'à 35 m/s.

Todas las poleas están equilibradas ESTÁTICAMENTE y son adecuadas para un funcionamiento de una velocidad de hasta 35 m/s.

La gamma proposta nel seguente catalogo, comprende: PULEGGE TRAPEZOIDALI, per bussola conica, serie ZT..... AT..... BT..... CT..... AT..... BT..... CT..... PULEGGE TRAPEZOIDALI monoblocco (con mozzo pieno) serie ZM..... AM..... BM..... CM..... PULEGGE TRAPEZOIDALI per calettatore.

The range proposed in this catalogue is the following: V-BELT PULLEYS for taper bush, series ZT..... AT..... BT..... CT..... V-BELT PULLEYS with solid hub, series ZM..... AM..... BM..... CM..... V-BELT PULLEYS for locking devices.

Die in diesem Katalog angegebene Palette ist die folgende: KEILRIEMENSCHLEIBEN fuer Spannbuchse, Serie ZT..... AT..... BT..... CT..... KEILRIEMENSCHLEIBEN ungebohrt, Serie ZM..... AM..... BM..... CM..... KEILRIEMENSCHLEIBEN fuer Spannsätze.

La gamme proposée dans ce catalogue est la suivante: POULIES TRAPEZOÏDALES pour moyeu amovible, série ZT..... AT..... BT..... CT..... POULIES TRAPEZOÏDALES à moyeu plein, série ZM..... AM..... BM..... CM..... POULIES TRAPEZOÏDALES pour à moyeu de serrage.

La gama propuesta en el siguiente catálogo comprende: POLEAS TRAPEZOIDALES para casquillos cónicos, serie ZT..... AT..... BT..... CT..... POLEAS TRAPEZOIDALES con cubo pleno, serie ZM..... AM..... BM..... CM..... POLEAS TRAPEZOIDALES para casquillos de fijación.

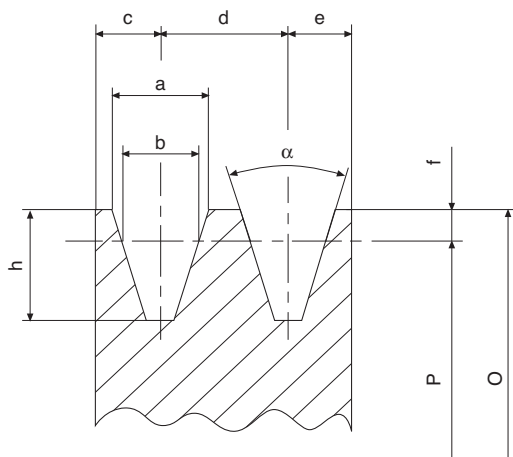

Calcolo della velocità periferica Vp in m/s
Calculation of peripheral speed Vp in m/s
Berechnung der Umfangsgeschwindigkeit Vp in m/s
Calcul de la vitesse périphérique Vp m/s
Cálculo de la velocidad periférica Vp en m/s

$$V_p = \frac{p \cdot P \cdot \text{rpm}}{60 \cdot 1000} @ \frac{P \cdot \text{rpm}}{19100} \quad V_p \leq 35 \text{ m/s}$$

P = Diametro primitivo in mm
 Pitch diameter in mm
 Teildurchmesser in mm
 Diamètre primitif en mm
 Diámetro primitivo en mm

rpm = Giri al minuto
 Revolutions per minute
 Umdrehungen pro Minute
 Tours par minute
 Revoluciones por minuto

Dimensioni puleggia Pulley dimintions Keilriemenscheibenabmessungen Dimensions poulie Dimensiones polea

	a	b	c	d	e	f	h	34°	38°
SPZ	9,7	8,5	8,0	12,0	8,0	2,0	11,0	P <= 80	P > 80
SPA	12,7	11,0	10,0	15,0	10,0	2,8	13,8	P <= 118	P > 118
SPB	16,3	14,0	12,5	19,0	12,5	3,5	17,5	P <= 190	P > 190
SPC	22,0	19,0	17,0	25,5	17,0	4,8	23,8	P <= 315	P > 315

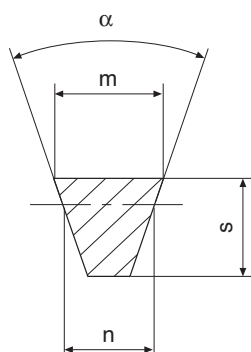

Dimensioni cinghia / Belt dimintions / Riemenabmessungen
Dimensions courroie / Dimensiones correa

	m	s	n
SPZ	9,7	8	8,5
SPA	12,7	10	11,0
SPB	16,3	13	14,0
SPC	22,0	18	19,0

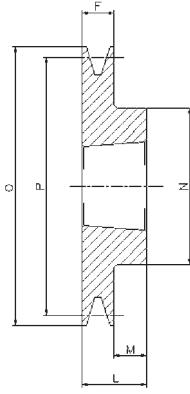

1

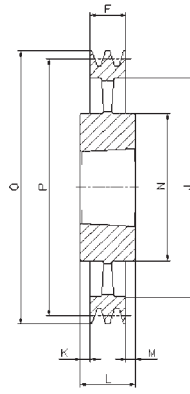

4

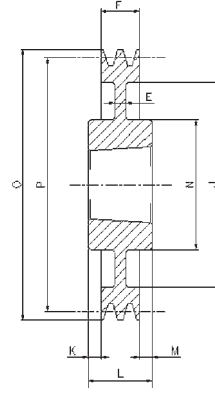

7

SPA/1

Cod. interno Internal code Internar Code Code interne Còdigo interno	Tipo Type Typ Type Tipo	Gole Grooves Rillen Gorges Canales	P	O	Forma Form Forme Forme Forma	Bussola Bush Buchse Moyeu Casquillo	Ø MAX	E	F	J	K	L	M	N
AT00631	SPA 63-01	1	63	68,5	1	1008	25	-	20	-	-	22	2	56
AT00671	SPA 67-01	1	67	72,5	1	1108	28	-	20	-	-	22	2	56
AT00711	SPA 71-01	1	71	76,5	1	1108	28	-	20	-	-	22	2	60
AT00751	SPA 75-01	1	75	80,5	1	1108	28	-	20	-	-	22	2	56
AT00801	SPA 80-01	1	80	85,5	1	1210	32	-	20	-	-	25	5	75
AT00851	SPA 85-01	1	85	90,5	1	1210	32	-	20	-	-	25	5	80
AT00901	SPA 90-01	1	90	95,5	1	1210	32	-	20	-	-	25	5	80
AT00951	SPA 95-01	1	95	100,5	1	1210	32	-	20	-	-	25	5	85
AT01001	SPA100-01	1	100	105,5	1	1610	42	-	20	-	-	25	5	85
AT01061	SPA106-01	1	106	111,5	1	1610	42	-	20	-	-	25	5	92
AT01121	SPA112-01	1	112	117,5	1	1610	42	-	20	-	-	25	5	92
AT01181	SPA118-01	1	118	123,5	1	1610	42	-	20	-	-	25	5	92
AT01251	SPA125-01	1	125	130,5	1	1610	42	-	20	-	-	25	5	92
AT01321	SPA132-01	1	132	137,5	1	1610	42	-	20	-	-	25	5	92
AT01401	SPA140-01	1	140	145,5	1	1610	42	-	20	-	-	25	5	92
AT01501	SPA150-01	1	150	155,5	1	1610	42	-	20	-	-	25	5	92
AT01601	SPA160-01	1	160	165,5	1	1610	42	-	20	-	-	25	5	92
AT01701	SPA170-01	1	170	175,5	1	1610	42	-	20	-	-	25	5	92
AT01801	SPA180-01	1	180	185,5	7	1610	42	6	20	145	-	25	5	92
AT01901	SPA190-01	1	190	195,5	7	1610	42	6	20	156	-	25	5	92
AT02001	SPA200-01	1	200	205,5	7	2012	50	6	20	165	-	32	12	108
AT02121	SPA212-01	1	212	217,5	7	2012	50	10	20	177	-	32	12	110
AT02241	SPA224-01	1	224	229,5	7	2012	50	10	20	189	-	32	12	112
AT02361	SPA236-01	1	236	241,5	7	2012	50	10	20	202	-	32	12	112
AT02501	SPA250-01	1	250	255,5	7	2012	50	10	20	215	6	32	6	112
AT02801	SPA280-01	1	280	285,5	7	2012	50	10	20	245	-	32	12	112
AT03001	SPA300-01	1	300	305,5	7	2012	50	12	20	265	-	32	12	112
AT03151	SPA315-01	1	315	320,5	7	2012	50	12	20	280	-	32	12	112
AT03551	SPA355-01	1	355	360,5	4	2012	50	-	20	320	-	32	12	112
AT04001	SPA400-01	1	400	405,5	4	2012	50	-	20	365	-	32	12	112
AT04501	SPA450-01	1	450	455,5	4	2012	50	-	20	415	-	32	12	112
AT05001	SPA500-01	1	500	505,5	4	2517	60	-	20	465	-	45	25	124
AT06301	SPA630-01	1	630	635,5	4	2517	60	-	20	595	-	45	25	124

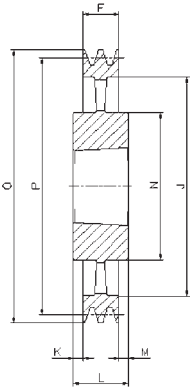
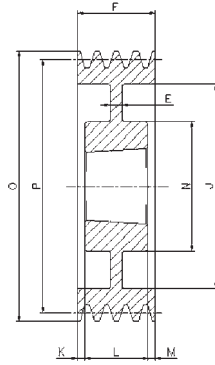
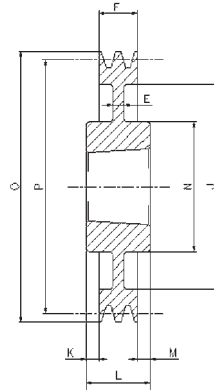
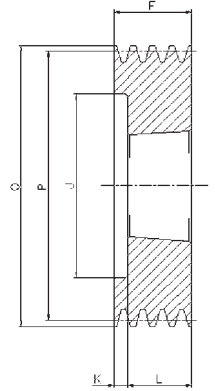

4

6

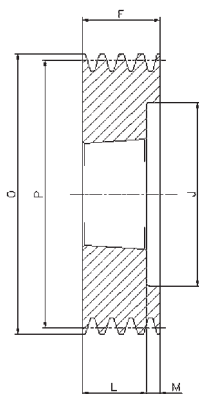
7

8

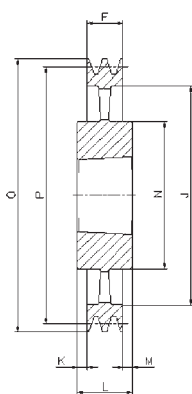
SPA/2

Cod. interno Internal code Intern Code Code interne Còdigo interno	Tipo Type Typ Type Tipo	Gole Grooves Rillen Gorges Canales	P	O	Forma Form Forme Forme Forma	Bussola Bush Buchse Moyeu Casquillo	Ø MAX	E	F	J	K	L	M	N
AT00632	SPA 63-02	2	63	68,5	8	1008	28	-	35	32,5	13,0	22	-	-
AT00672	SPA 67-02	2	67	72,5	8	1108	28	-	35	37,0	13,0	22	-	-
AT00712	SPA 71-02	2	71	76,5	8	1108	28	-	35	40,0	13,0	22	-	-
AT00752	SPA 75-02	2	75	80,5	8	1108	28	-	35	44,0	13,0	22	-	-
AT00802	SPA 80-02	2	80	85,5	8	1210	32	-	35	50,0	10,0	25	-	-
AT00852	SPA 85-02	2	85	90,5	8	1210	32	-	35	55,0	10,0	25	-	-
AT00902	SPA 90-02	2	90	95,5	8	1610	42	-	35	59,0	10,0	25	-	-
AT00952	SPA 95-02	2	95	100,5	8	1610	42	-	35	63,0	10,0	25	-	-
AT01002	SPA100-02	2	100	105,5	8	1610	42	-	35	66,0	10,0	25	-	-
AT01062	SPA106-02	2	106	111,5	8	1610	42	-	35	72,0	10,0	25	-	-
AT01122	SPA112-02	2	112	117,5	8	1610	42	-	35	78,0	10,0	25	-	-
AT01182	SPA118-02	2	118	123,5	8	1610	42	-	35	84,0	10,0	25	-	-
AT01252	SPA125-02	2	125	130,5	8	1610	42	-	35	91,0	10,0	25	-	-
AT01322	SPA132-02	2	132	137,5	8	2012	50	-	35	98,0	3,0	32	-	-
AT01402	SPA140-02	2	140	145,5	8	2012	50	-	35	106,0	3,0	32	-	-
AT01502	SPA150-02	2	150	155,5	8	2012	50	-	35	116,0	3,0	32	-	-
AT01602	SPA160-02	2	160	165,5	8	2012	50	-	35	125,0	3,0	32	-	-
AT01702	SPA170-02	2	170	175,5	8	2012	50	-	35	135,0	3,0	32	-	-
AT01802	SPA180-02	2	180	185,5	6	2012	50	10	35	146,0	1,5	32	1,5	108
AT01902	SPA190-02	2	190	195,5	6	2012	50	10	35	156,0	1,5	32	1,5	108
AT02002	SPA200-02	2	200	205,5	7	2517	60	10	35	165,0	5,0	45	5,0	123
AT02122	SPA212-02	2	212	217,5	7	2517	60	18	35	177,0	5,0	45	5,0	123
AT02242	SPA224-02	2	224	229,5	7	2517	60	18	35	189,0	-	45	10,0	124
AT02362	SPA236-02	2	236	241,5	7	2517	60	12	35	202,0	-	45	10,0	124
AT02502	SPA250-02	2	250	255,5	7	2517	60	12	35	215,0	5,0	45	5,0	124
AT02802	SPA280-02	2	280	285,5	7	2517	60	12	35	245,0	-	45	10,0	124
AT03002	SPA300-02	2	300	305,5	7	2517	60	12	35	265,0	-	45	10,0	124
AT03152	SPA315-02	2	315	320,5	7	2517	60	12	35	280,0	-	45	10,0	124
AT03552	SPA355-02	2	355	360,5	4	2517	60	-	35	320,0	-	45	10,0	124
AT04002	SPA400-02	2	400	405,5	4	2517	60	-	35	365,0	-	45	10,0	124
AT04502	SPA450-02	2	450	455,5	4	2517	60	-	35	465,0	-	45	10,0	124
AT05002	SPA500-02	2	500	505,5	4	2517	60	-	35	525,0	-	45	10,0	125
AT06302	SPA630-02	2	630	635,5	4	3020	75	-	35	595,0	8,0	51	18,0	159



2



4

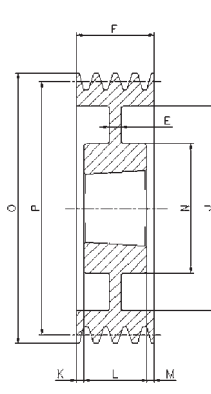

6

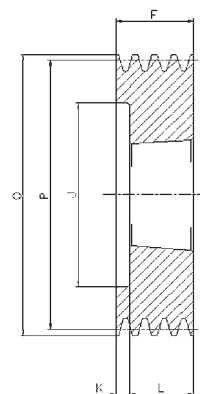

8

SPA/3

Cod. interno Internal code Interne Code Code interne Código interno	Tipo Type Typ Type Tipo	Gole Grooves Rillen Gorges Canales	P	O	Forma Form Forme Forme Forma	Bussola Bush Buchse Moyeu Casquillo	∅ MAX	E	F	J	K	L	M	N
AT00713	SPA 71-03	3	71	76,5	8	1108	28	-	50	40	28,0	22	-	-
AT00753	SPA 75-03	3	75	80,5	8	1108	28	-	50	44	28,0	22	-	-
AT00803	SPA 80-03	3	80	85,5	8	1210	32	-	50	50	25,0	25	-	-
AT00853	SPA 85-03	3	85	90,5	8	1210	32	-	50	55	25,0	25	-	-
AT00903	SPA 90-03	3	90	95,5	8	1610	42	-	50	59	25,0	25	-	-
AT00953	SPA 95-03	3	95	100,5	8	1610	42	-	50	63	25,0	25	-	-
AT01003	SPA100-03	3	100	105,5	2	1610	42	-	50	66	-	25	25,0	-
AT01063	SPA106-03	3	106	111,5	2	1610	42	-	50	72	-	25	25,0	-
AT01123	SPA112-03	3	112	117,5	8	2012	50	-	50	78	18,0	32	-	-
AT01183	SPA118-03	3	118	123,5	2	2012	50	-	50	84	-	32	18,0	-
AT01253	SPA125-03	3	125	130,5	2	2012	50	-	50	91	-	32	18,0	-
AT01323	SPA132-03	3	132	137,5	2	2012	50	-	50	98	-	32	18,0	-
AT01403	SPA140-03	3	140	145,5	8	2517	60	-	50	106	5,0	45	-	-
AT01503	SPA150-03	3	150	155,5	8	2517	60	-	50	116	5,0	45	-	-
AT01603	SPA160-03	3	160	165,5	8	2517	60	-	50	125	5,0	45	-	-
AT01703	SPA170-03	3	170	175,5	8	2517	60	-	50	135	5,0	45	-	-
AT01803	SPA180-03	3	180	185,5	8	2517	60	-	50	146	5,0	45	-	-
AT01903	SPA190-03	3	190	195,5	8	2517	60	-	50	156	5,0	45	-	-
AT02003	SPA200-03	3	200	205,5	6	2517	60	20	50	165	2,5	45	2,5	123
AT02123	SPA212-03	3	212	217,5	6	2517	60	20	50	177	2,5	45	2,5	123
AT02243	SPA224-03	3	224	229,5	6	2517	60	20	50	189	2,5	45	2,5	124
AT02363	SPA236-03	3	236	241,5	6	2517	60	20	50	202	2,5	45	2,5	124
AT02503	SPA250-03	3	250	255,5	6	2517	60	20	50	215	2,5	45	2,5	124
AT02803	SPA280-03	3	280	285,5	6	2517	60	20	50	245	2,5	45	2,5	124
AT03003	SPA300-03	3	300	305,5	4	3020	75	-	50	265	0,5	51	0,5	146
AT03153	SPA315-03	3	315	320,5	4	3020	75	-	50	280	0,5	51	0,5	159
AT03553	SPA355-03	3	355	360,5	4	3020	75	-	50	320	0,5	51	0,5	159
AT04003	SPA400-03	3	400	405,5	4	3020	75	-	50	365	-	51	1,0	159
AT04503	SPA450-03	3	450	455,5	4	3020	75	-	50	415	-	51	1,0	159
AT05003	SPA500-03	3	500	505,5	4	3020	75	-	50	465	-	51	1,0	159
AT05603	SPA560-03	3	560	565,5	4	3020	75	-	50	525	-	51	1,0	150
AT06303	SPA630-03	3	630	635,5	4	3020	75	-	50	595	-	51	1,0	150
AT08003	SPA800-03	3	800	805,5	4	3535	90	-	50	765	19,5	89	19,5	175
AT10003	SPA1000-03	3	1000	1005,5	4	3535	90	-	50	965	19,5	89	19,5	175

Forma / Form / Forme / Forme / Forma

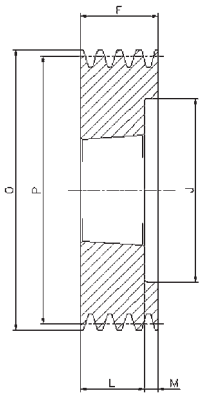

2

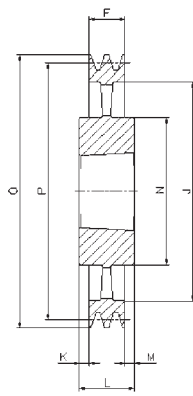

4

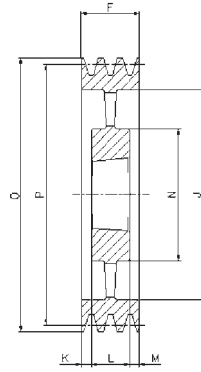

5

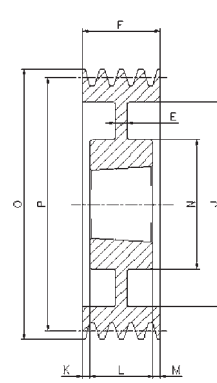

6

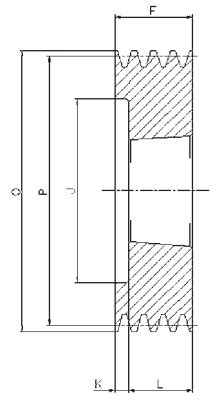

8

SPA/4

Cod. interno Internal code Intern Code Code interne Código interno	Tipo Type Typ Type Tipo	Gole Grooves Rillen Gorges Canales	P	O	Forma Form Forme Forme Forma	Bussola Bush Buchse Moyeu Casquillo	∅ MAX	E	F	J	K	L	M	N
AT00804	SPA 80-04	4	80	85,5	8	1215	28	-	65	49	27	38	-	-
AT00904	SPA 90-04	4	90	95,5	8	1615	42	-	65	59	27,0	38	-	-
AT00954	SPA 95-04	4	95	100,5	8	1615	42	-	65	63	27,0	38	-	-
AT01004	SPA100-04	4	100	105,5	2	1615	42	-	65	66	-	38	27,0	-
AT01064	SPA106-04	4	106	111,5	8	2012	50	-	65	72	33,0	32	-	-
AT01124	SPA112-04	4	112	117,5	8	2012	50	-	65	78	33,0	32	-	-
AT01184	SPA118-04	4	118	123,5	2	2012	50	-	65	84	-	32	33,0	-
AT01254	SPA125-04	4	125	130,5	2	2012	50	-	65	91	-	32	33,0	-
AT01324	SPA132-04	4	132	137,5	2	2517	60	-	65	98	-	45	20,0	-
AT01404	SPA140-04	4	140	145,5	2	2517	60	-	65	106	-	45	20,0	-
AT01504	SPA150-04	4	150	155,5	2	2517	60	-	65	116	-	45	20,0	-
AT01604	SPA160-04	4	160	165,5	2	2517	60	-	65	125	-	45	20,0	-
AT01704	SPA170-04	4	170	175,5	2	2517	60	-	65	135	-	45	20,0	-
AT01804	SPA180-04	4	180	185,5	2	2517	60	-	65	146	-	45	20,0	-
AT01904	SPA190-04	4	190	195,5	2	2517	60	-	65	156	-	45	20,0	-
AT02004	SPA200-04	4	200	205,5	2	3020	75	-	65	165	-	51	14,0	-
AT02124	SPA212-04	4	212	217,5	2	3020	75	-	65	177	-	51	14,0	-
AT02244	SPA224-04	4	224	229,5	2	3020	75	-	65	189	-	51	14,0	-
AT02364	SPA236-04	4	236	241,5	6	3020	75	25	65	202	-	51	14,0	-
AT02504	SPA250-04	4	250	255,5	6	3020	75	20	65	215	7,0	51	7,0	159
AT02804	SPA280-04	4	280	285,5	6	3020	75	25	65	245	7,0	51	7,0	159
AT03004	SPA300-04	4	300	305,5	6	3020	75	25	65	265	7,0	51	7,0	159
AT03154	SPA315-04	4	315	320,5	6	3020	75	25	65	280	7,0	51	7,0	159
AT03554	SPA355-04	4	355	360,5	5	3020	75	-	65	320	7,0	51	7,0	159
AT04004	SPA400-04	4	400	405,5	5	3020	75	-	65	365	7,0	51	7,0	159
AT04504	SPA450-04	4	450	455,5	5	3020	75	-	65	415	7,0	51	7,0	159
AT05004	SPA500-04	4	500	505,5	5	3020	75	-	65	465	7,0	51	7,0	159
AT05604	SPA560-04	4	560	565,5	4	3535	90	-	65	525	12,0	89	12,0	175
AT06304	SPA630-04	4	630	635,5	4	3535	90	-	65	595	12,0	89	12,0	175
AT08004	SPA800-04	4	800	805,5	4	3535	90	-	65	765	12,0	89	12,0	175
AT10004	SPA1000-04	4	1000	1005,5	4	4040	100	-	65	965	18,5	102	18,5	210

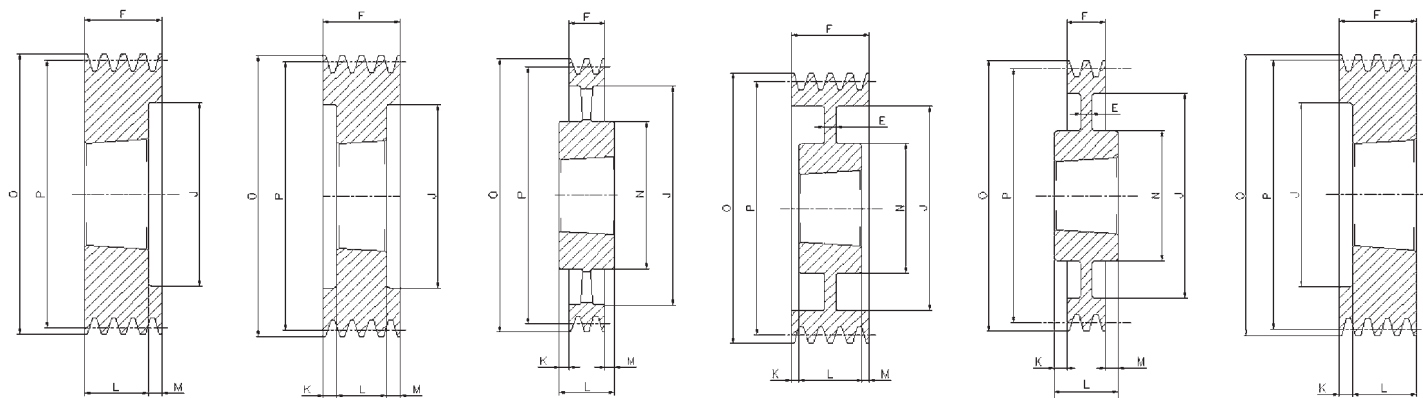

2

3

4

6

7

8

SPA/5

Cod. interno Internal code Interner Code Code interne Código interno	Tipo Type Typ Type Tipo	Gole Grooves Rillen Gorges Canales	P	O	Forma Form Forme Forme Forma	Bussola Bush Buchse Moyeu Casquillo	∅ MAX	E	F	J	K	L	M	N
AT01005	SPA100-05	5	100	105,5	2	1615	42	-	80	66	-	38	42,0	-
AT01065	SPA106-05	5	106	111,5	8	2012	50	-	80	72	48,0	32	-	-
AT01125	SPA112-05	5	112	117,5	8	2012	50	-	80	78	48,0	32	-	-
AT01185	SPA118-05	5	118	123,5	2	2012	50	-	80	84	-	32	48,0	-
AT01255	SPA125-05	5	125	130,5	3	2012	50	-	80	91	24,0	32	24,0	-
AT01325	SPA132-05	5	132	137,5	3	2517	60	-	80	98	17,5	45	17,5	-
AT01405	SPA140-05	5	140	145,5	3	2517	60	-	80	106	17,5	45	17,5	-
AT01505	SPA150-05	5	150	155,5	3	2517	60	-	80	116	17,5	45	17,5	-
AT01605	SPA160-05	5	160	165,5	3	2517	60	-	80	125	17,5	45	17,5	-
AT01705	SPA170-05	5	170	175,5	3	2517	60	-	80	135	17,5	45	17,5	-
AT01805	SPA180-05	5	180	185,5	3	3020	75	-	80	146	-	51	29,0	-
AT01905	SPA190-05	5	190	195,5	2	3020	75	-	80	156	14,5	51	14,5	-
AT02005	SPA200-05	5	200	205,5	3	3020	75	-	80	165	14,5	51	14,5	-
AT02125	SPA212-05	5	212	217,5	2	3020	75	-	80	177	-	51	29,0	-
AT02245	SPA224-05	5	224	229,5	2	3020	75	-	80	189	-	51	29,0	-
AT02365	SPA236-05	5	236	241,5	2	3020	75	-	80	202	-	51	29,0	-
AT02505	SPA250-05	5	250	255,5	6	3020	75	20	80	215	14,5	51	14,5	159
AT02805	SPA280-05	5	280	285,5	7	3535	90	25	80	245	4,5	89	4,5	175
AT03005	SPA300-05	5	300	305,5	7	3535	90	25	80	265	4,5	89	4,5	175
AT03155	SPA315-05	5	315	320,5	7	3535	90	25	80	280	4,5	89	4,5	175
AT03555	SPA355-05	5	355	360,5	4	3535	90	-	80	320	4,5	89	4,5	175
AT04005	SPA400-05	5	400	405,5	4	3535	90	-	80	365	4,5	89	4,5	175
AT04505	SPA450-05	5	450	455,5	4	3535	90	-	80	415	4,5	89	4,5	175
AT05005	SPA500-05	5	500	505,5	4	3535	90	-	80	465	4,5	89	4,5	175
AT05605	SPA560-05	5	560	565,5	4	3535	90	-	80	525	4,5	89	4,5	175
AT06305	SPA630-05	5	630	635,5	4	3535	90	-	80	595	4,5	89	4,5	175
AT08005	SPA800-05	5	800	805,5	4	4040	100	-	80	765	11,0	102	11,0	210
AT10005	SPA1000-05	5	1000	1005,5	4	4545	110	-	80	965	17,0	114	17,0	242

Forma / Form / Forme / Forme / Forma

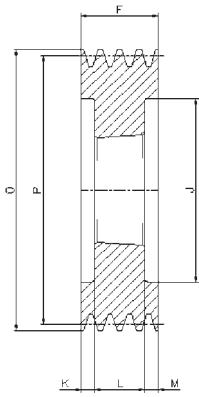

3

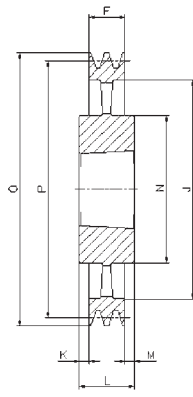

4

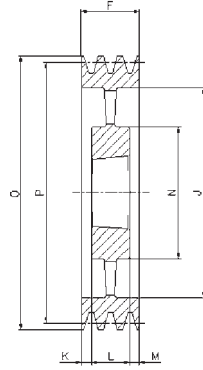

5

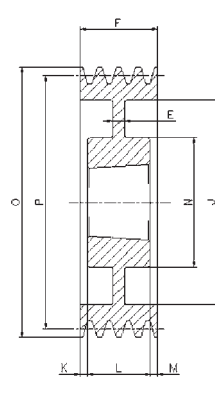

6

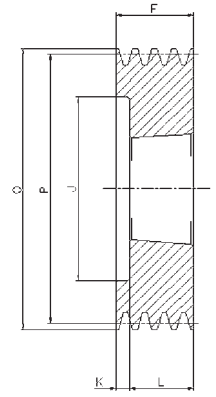

8

SPA/6

Cod. interno Internal code Interne Code Code interne Código interno	Tipo Type Typ Type Tipo	Gole Grooves Rillen Gorges Canales	P	O	Forma Form Forme Forme Forma	Bussola Bush Buchse Moyeu Casquillo	∅ MAX	E	F	J	K	L	M	N
AT01006	SPA100-06	6	100	105,5	3	1610	42	-	95	66	30,0	25	40,0	-
AT01066	SPA106-06	6	106	111,5	8	2012	50	-	95	72	63,0	32	-	-
AT01126	SPA112-06	6	112	117,5	8	2012	50	-	95	78	63,0	32	-	-
AT01186	SPA118-06	6	118	123,5	8	2012	50	-	95	84	63,0	32	-	-
AT01256	SPA125-06	6	125	130,5	3	2012	50	-	95	91	31,5	32	31,5	-
AT01326	SPA132-06	6	132	137,5	3	2517	60	-	95	98	25,0	45	25,0	-
AT01406	SPA140-06	6	140	145,5	3	2517	60	-	95	106	25,0	45	25,0	-
AT01506	SPA150-06	6	150	155,5	3	2517	60	-	95	116	25,0	45	25,0	-
AT01606	SPA160-06	6	160	165,5	3	2517	60	-	95	125	25,0	45	25,0	-
AT01806	SPA180-06	6	180	185,5	3	3020	75	-	95	146	22,0	51	22,0	-
AT02006	SPA200-06	6	200	205,5	3	3020	75	-	95	165	22,0	51	22,0	-
AT02126	SPA212-06	6	212	217,5	3	3020	75	-	95	176	22,0	51	22,0	-
AT02246	SPA224-06	6	224	229,5	3	3020	75	-	95	189	22,0	51	22,0	-
AT02366	SPA236-06	6	236	241,5	3	3020	75	-	95	202	22,0	51	22,0	-
AT02506	SPA250-06	6	250	255,5	6	3020	75	20	95	215	22,0	51	22,0	155
AT02806	SPA280-06	6	280	285,5	6	3535	90	25	95	245	3,0	89	3,0	175
AT03006	SPA300-06	6	300	305,5	6	3535	90	25	95	265	3,0	89	3,0	175
AT03156	SPA315-06	6	315	320,5	6	3535	90	25	95	280	3,0	89	3,0	175
AT03556	SPA355-06	6	355	360,5	5	3535	90	-	95	320	3,0	89	3,0	175
AT04006	SPA400-06	6	400	405,5	5	3535	90	-	95	365	3,0	89	3,0	175
AT04506	SPA450-06	6	450	455,5	5	3535	90	-	95	415	3,0	89	3,0	175
AT05006	SPA500-06	6	500	505,5	5	3535	90	-	95	465	3,0	89	3,0	175
AT05606	SPA560-06	6	560	565,5	5	3535	90	-	95	525	3,0	89	3,0	175
AT06306	SPA630-06	6	630	635,5	4	4040	100	-	95	595	3,5	102	3,5	210
AT08006	SPA800-06	6	800	805,5	4	4040	100	-	95	765	3,5	102	3,5	210
AT10006	SPA1000-06	6	1000	1005,5	4	4545	110	-	95	965	9,5	114	9,5	242

Morskate®



Any questions? Please contact us.

Morskate Aandrijvingen BV

Oosterveldsingel 47A
7558 PJ Hengelo (Ov)
The Netherlands

NL

T +31 (0)74 - 760 11 11
info@morskateaandrijvingen.nl
www.morskateaandrijvingen.nl

DE

T +49 692 - 222 34 95
info@morskateantriebstechnik.de
www.morskateantriebstechnik.de

EN

T +31 (0)74 - 760 11 11
info@morskatedrivetechnology.com
www.morskatedrivetechnology.com